



VERSA COMMERCIAL

4" LED COMMERCIAL DOWNLIGHT NEW CONSTRUCTION

JOB INFORMATION	TYPE:
	CATALOG NO.
	PROJECT NAME:
	COMMENTS:
	PREPARED BY:

FEATURES

USE OF PRODUCT

The 4" Versa Commercial LED Downlight is the ideal product for energy efficient lighting in Non-IC New Construction commercial applications. Available with interchangeable reflectors and trims, with an assortment of color temperatures, lenses, filters and dimmable driver options.

VERSA COMMERCIAL FEATURES

Wattage	Lumens	Voltage	CRI
11W	1,045 lm	120-277V	93+
16W	1,350 lm	120-277V	93+
20W	1,635 lm	120-277V	93+
21W	1,895 lm	120-277V	93+
30W	2,130 lm	120-277V	93+
31W	2,475 lm	120-277V	93+
38W	2,930 lm	120-277V	93+
45W	3,255 lm	120-277V	93+
58W	4,000 lm	120-277V	93+

*Performance based on 3000K

Color Temperature: 2700K, 3000K, 3500K, or 4000K
 SDCCM: 2 step binning
 Color Rendering Index: 93+ CRI
 R9: 60+
 Optical Lens: 18°, 30°, 50°, 80°
 Filter Accessories: Solite, frosted or honeycomb
 LED Life: 50,000 Hours
 LED Type: Cree LED
 Driver Info: 120-277V, 50/60 Hz, PF>0.9, THD<0.20
 Versatility: Interchangeable reflector/trim ring, optics & filters
 Warranty: 5 year limited warranty

LED ENGINE

LED engine available with CREE LEDs in 2700K, 3000K, 3500K, or 4000K in standard 93+ CRI. 2 Step MacAdam ellipse allows for color consistency between fixtures. LED mounted to aluminum heat sink for maximum life output and thermal management.

FRAME CONSTRUCTION

Constructed from 16 gauge heavy duty powder coated cold rolled steel frame with a large access junction box.

OPTICAL LENS (Field Replaceable)

Field replaceable optical lens available in 18°, 30°, 50° and 80°. Easily achieve narrow spot to wide flood beam pattern.

FILTER ACCESSORIES

A multitude of filter accessories are available to achieve a particular light effect. Available in frosted, honeycomb, or solite filter options.

DIMMING

Available in 7 driver selections. **(ID)** Standard all-inclusive ELV, Triac, and 0-10V dimming driver called Intelligent Drive, 120-277V. **(LDE1)** Lutron Hi-Lume 1% Ecosystem with soft on, fade to black dimming, 120-277V. **(LTE)** Hi-Lume 1% 2-wire, 120V **(EEI)** eldoLED Eco 1% Dim (0-10V), 120-277V. **(EDIO)** eldoLED Solo 0.1% Dim (0-10V), 120-277V. **(EDID)** eldoLED Solo 0.1% Dim (DALI), 120-277V.

VERSATILITY

The Versa Commercial LED Downlight series provides for interchangeable reflectors and trims in round shape with an assortment of finishes to achieve a particular look. The ability to field install and/or replace various reflectors, trims, optics & filters makes the Versa Commercial Downlight Series the most flexible commercial downlight in the industry.

EMERGENCY BATTERY

Optional emergency battery available for a minimum of 90 minutes with both integral or remote test switch in 800 or 1700 delivered lumens.

INSTALLATION

Non-IC housing. Insulation must be kept at least 3" away from fixture.

LABELS/COMPLIANCE/WARRANTY

-CSA Listed for US and Canada
 -5 year limited warranty.

ORDERING INFORMATION



Series	Lumens	Color Temp	Voltage	Dimming	Optical Lens
RVC4	10L - 1045 lm	27 - 2700K	UNV - 120-277V	ID ² - Standard all-inclusive ELV, Triac, and 0-10V dimming driver (Intelligent Drive)	18 - 18° Beam
	13L - 1350 lm	30 - 3000K	1 - 120V	LDE1 - Lutron Hi-Lume 1% Ecosystem with soft on, fade to black dimming	30 - 30° Beam
	16L - 1635 lm	35 - 3500K	3 ¹ - 347V	LTE ³ - Hi-Lume 1% 2-wire	50 - 50° Beam
	18L - 1895 lm	40 - 4000K		EEI ^{4,5} - eldoLED Eco 1% Dim (0-10V)	80 - 80° Beam
	21L - 2130 lm			EDIO ^{4,5} - eldoLED Solo 0.1% Dim (0-10V)	
	24L - 2475 lm			EDID ^{4,5} - eldoLED Solo 0.1% Dim (DALI)	
	29L - 2930 lm				
	32L - 3255 lm				
	40L - 4000 lm				

Reflector	Trim	Frame	Frame Accessories	Options
4RW - White	4TW - White	FN - New Construction	C - C Channel bar hanger	E18 - Emergency Battery with Integral Switch (800 Lumens)
4RS - Specular Clear	4TS - Specular Clear		B - Flat bar hanger	ER8 - Emergency Battery with Remote Switch (800 Lumens)
4RH - Haze	4TH - Haze		WJ - Wood joist	E117 - Emergency Battery with Integral Switch (1700 Lumens)
4RB - Black	4TB - Black			ER17 - Emergency Battery with Remote Switch (1700 Lumens)
MTO - Made to order	MTO - Made to order			WL - Wet Location
				F - Frosted filter
				H - Honeycomb
				S - Solite filter

4" LED COMMERCIAL DOWNLIGHT NEW CONSTRUCTION

- Step down transformer required.
- Intelligent Drive is the standard driver for the Versa Commercial.
- 120V only.
- Inapplicable to 4000 Lumen offering.
- Must specify logarithmic or linear eldoLED driver.



www.rayonlighting.com
 info@rayonlighting.com

Tel: 323.446.2626
 Fax: 323.446.2606

Specification and product availability
 subject to change without notice

FRAME ACCESSORIES

WJ

Slotted Holes allow for an easier installation

4" up to 8" CKOs

Wood Joist

Fits up to 26" stud spacings

Plate is offset, allowing for adjustability with irregular stud spacing

B

27"

1/2"

Flat Bar Hanger

C

25-3/16"

1-6/16"

C Channel Bar Hanger

VERSA COMMERCIAL

4" LED COMMERCIAL DOWNLIGHT
NEW CONSTRUCTION

PROJECT:

MODEL #:

LOCATION:

CONTACT:

DIMENSIONS

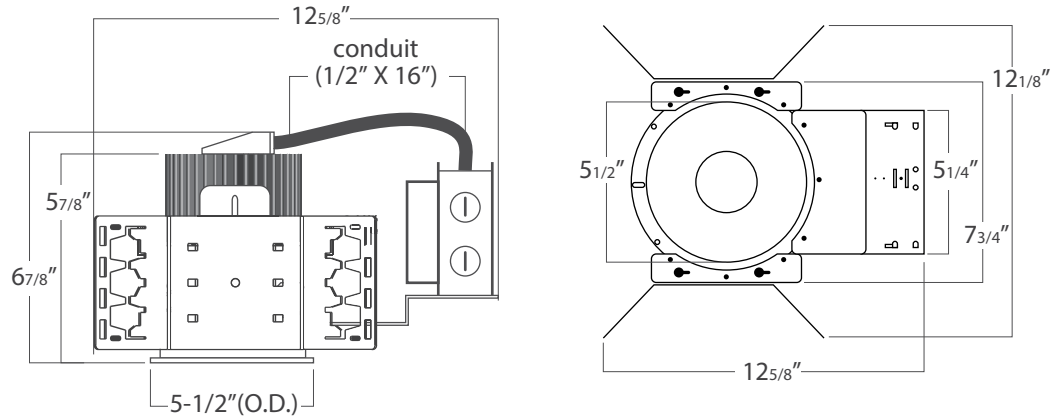

REFLECTOR/TRIM DIMENSIONS

REFLECTOR/TRIM



4" LED COMMERCIAL DOWNLIGHT NEW CONSTRUCTION

VERSA COMMERCIAL

4" LED COMMERCIAL DOWNLIGHT
NEW CONSTRUCTION

PROJECT:

MODEL #:

LOCATION:

CONTACT:

ANATOMY

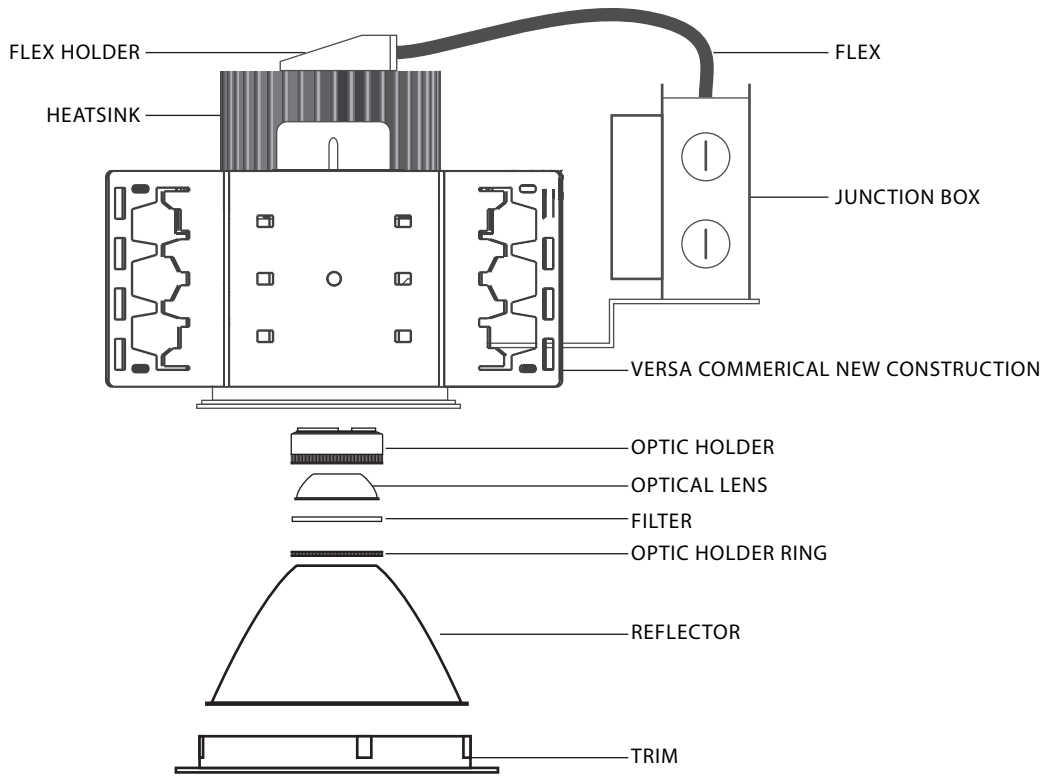

4" LED COMMERCIAL DOWNLIGHT NEW CONSTRUCTION

VERSA COMMERCIAL
4" LED COMMERCIAL DOWNLIGHT
NEW CONSTRUCTION

PROJECT:

MODEL #:

LOCATION:

CONTACT:

PHOTOMETRICS

30° BEAM

TEST DATE 18Sep16
SERIES RVC4
FRAME New Construction
LUMENS 2145.2
WATTS 38.471

POLAR CANDELA DISTRIBUTION

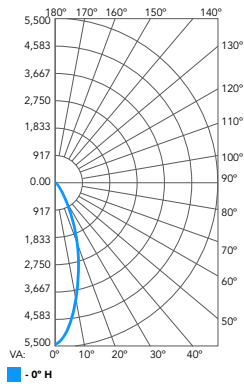

CANDELA DISTRIBUTION

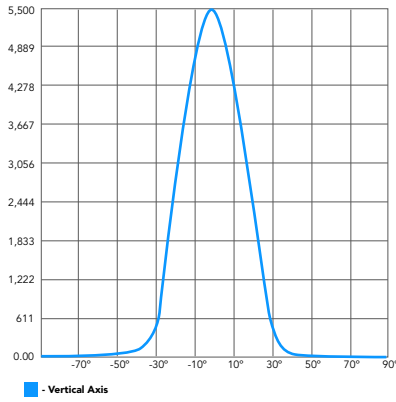

LUMENS PER ZONE

ZONE	LUMENS	% TOTAL
0-10	457.1	21.3%
10-20	875.2	40.8%
20-30	547.0	25.5%
30-40	159.2	7.4%
40-50	42.1	2.0%
50-60	28.9	1.3%
60-70	20.3	0.9%
70-80	12.3	0.6%
80-90	4.2	0.2%

LCS TABLE

BUG RATING	B2 - UX - GO	
	LUMENS	LUMENS%
FORWARD LIGHT		
LOW(0-30):	890.5	41.5%
MEDIUM(30-60):	109.6	5.1%
HIGH(60-80):	14.4	0.7%
VERY HIGH(80-90):	1.2	0.1%
BACK LIGHT		
LOW(0-30):	991.6	46.2%
MEDIUM(30-60):	120.6	5.6%
HIGH(60-80):	18.3	0.9%
VERY HIGH(80-90):	2.9	0.1%
TRAPPED LIGHT:	0.000	0%

ILLUMINANCE AT A DISTANCE

H HEIGHT(FT)	CENTER BEAM FOOTCANDLE	BEAM SPREAD(FT)		FIELD SPREAD(FT)	
		HORIZONTAL	VERTICAL	HORIZONTAL	VERTICAL
4.00	339.88 FC	2.5	2.5	4.6	4.6
8.00	84.97 FC	5.0	5.0	9.2	9.2
12.00	37.76 FC	7.5	7.4	13.8	13.8
16.00	21.24 FC	10.0	9.9	18.4	18.4
4.00	13.60 FC	12.4	12.4	23.0	23.0

BEAM ANGLE: 34.6° FIELD ANGLE: 59.9°
34.5° 59.7°

50° BEAM

TEST DATE 18Sep16
SERIES RVC4
FRAME New Construction
LUMENS 2019.5
WATTS 38.3869

POLAR CANDELA DISTRIBUTION

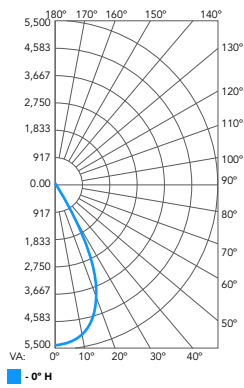

CANDELA DISTRIBUTION

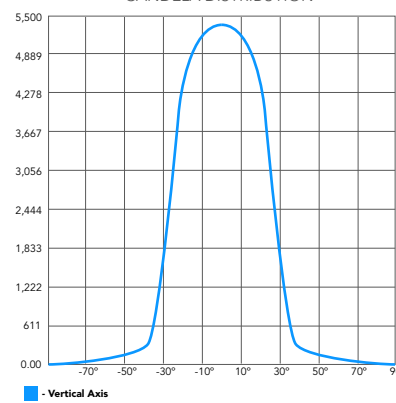

LUMENS PER ZONE

ZONE	LUMENS	% TOTAL
0-10	255.1	12.6%
10-20	679.0	33.6%
20-30	686.5	34.0%
30-40	223.1	11.0%
40-50	68.1	3.4%
50-60	50.1	2.5%
60-70	33.3	1.7%
70-80	18.8	0.9%
80-90	5.6	0.3%

LCS TABLE

BUG RATING	B2 - UX - GO	
	LUMENS	LUMENS%
FORWARD LIGHT		
LOW(0-30):	787.3	39%
MEDIUM(30-60):	159.1	7.9%
HIGH(60-80):	24.2	1.2%
VERY HIGH(80-90):	2.0	0.1%
BACK LIGHT		
LOW(0-30):	834.7	41.3%
MEDIUM(30-60):	182.1	9%
HIGH(60-80):	28.0	1.4%
VERY HIGH(80-90):	3.6	0.2%
TRAPPED LIGHT:	0.000	0%

ILLUMINANCE AT A DISTANCE

H HEIGHT(FT)	CENTER BEAM FOOTCANDLE	BEAM SPREAD(FT)		FIELD SPREAD(FT)	
		HORIZONTAL	VERTICAL	HORIZONTAL	VERTICAL
4.00	171.64 FC	4.0	3.9	5.7	5.7
8.00	42.91 FC	8.0	7.9	11.5	11.3
12.00	19.07 FC	11.9	11.8	17.2	17.0
16.00	10.73 FC	15.9	15.7	23.0	22.7
20.00	6.87 FC	19.9	19.7	28.7	28.3

BEAM ANGLE: 52.9° FIELD ANGLE: 71.3°
52.3° 70.6°

VERSA COMMERCIAL
4" LED COMMERCIAL DOWNLIGHT
NEW CONSTRUCTION

PROJECT:

MODEL #:

LOCATION:

CONTACT:

PHOTOMETRICS

70° BEAM

TEST DATE 18Sep16
SERIES RVC4
FRAME New Construction
LUMENS 1835
WATTS 38.3607

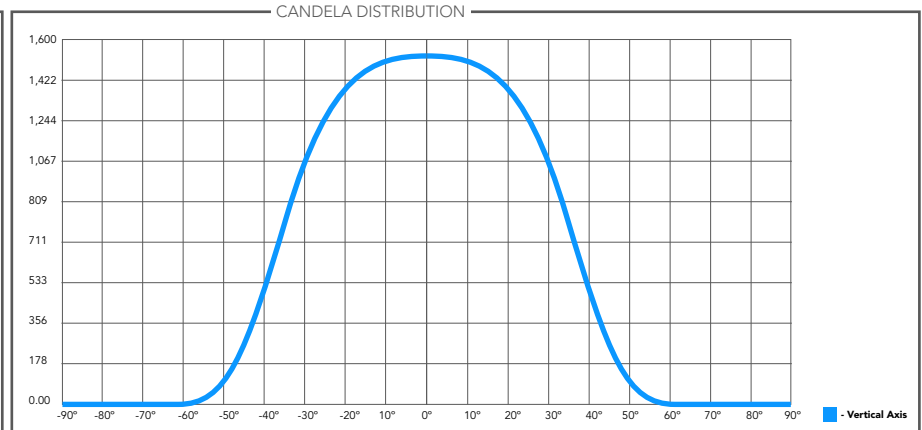
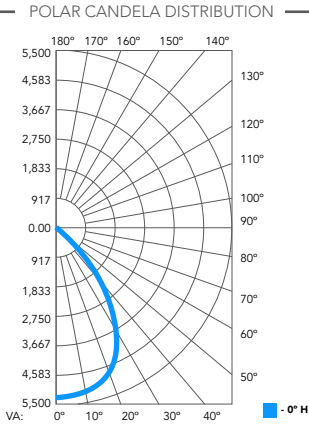

LUMENS PER ZONE

ZONE	LUMENS	% TOTAL
0-10	144.6	7.9%
10-20	409.6	22.3%
20-30	565.9	30.9%
30-40	484.3	26.4%
40-50	205.7	11.2%
50-60	23.0	1.3%
60-70	0.000	0.0%
70-80	0.000	0.0%
80-90	0.000	0.0%

LCS TABLE

BUG RATING	B2 - U0 - GO	
	LUMENS	LUMENS%
FORWARD LIGHT		
LOW(0-30):	560.3	30.6%
MEDIUM(30-60):	356.6	19.5%
HIGH(60-80):	0.000	0%
VERY HIGH(80-90):	0.000	0%
BACK LIGHT		
LOW(0-30):	560.3	30.6%
MEDIUM(30-60):	356.6	19.5%
HIGH(60-80):	0.000	0%
VERY HIGH(80-90):	0.000	0%
UP LIGHT		
LOW(90-100):	0.000	0%
HIGH(100-180):	0.000	0%
TRAPPED LIGHT:	0.000	0%

ILLUMINANCE AT A DISTANCE



H	
HEIGHT(FT)	CENTER BEAM FOOTCANDLE
4.00	95.41 FC
8.00	23.85 FC
12.00	10.60 FC
16.00	5.96 FC
20.00	3.82 FC

D			
BEAM SPREAD(FT)		FIELD SPREAD(FT)	
HORIZONTAL	VERTICAL	HORIZONTAL	VERTICAL
5.7	5.7	8.8	8.8
11.4	11.3	17.6	17.6
17.0	17.0	26.5	26.4
22.7	22.6	35.3	35.2
28.4	28.3	44.1	44.0

BEAM ANGLE		FIELD ANGLE	
70.7°	70.6°	95.6°	95.5°

4" LED COMMERCIAL DOWNLIGHT NEW CONSTRUCTION